

Technical datasheet

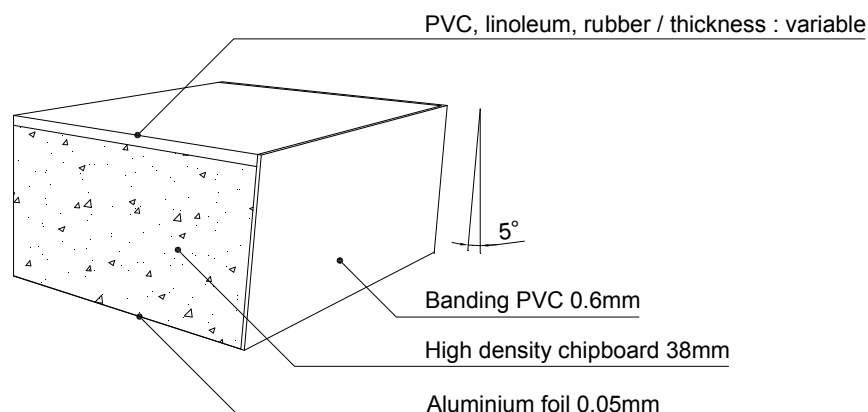

38 HAB-P-LCH

Tested according the European norm 12825

General characteristics

Measurements	:	600 x 600 mm
Weight	:	+/- 10 kgs
Core	:	38 mm chipboard - density 720 kgs/m ³ -E1
Bottom side	:	Aluminiumfoil 0,05mm
Upper side	:	Covered with conductive PVC, linoleum or rubber
Edge banding	:	Conductive PVC 0,6 mm

System characteristics

Class of element	:	1
Ultimate load	:	≥ 4 kN
Safety factor	:	2
Point load (= ultimate load/safety factor)	:	2 kN
Class of deflection (max 2,5mm deflection by 2Kn)	:	A
Divided load per m ² (Theoretical value)	:	10kN–15kN / m ²

Fire characteristics

Fire resistance	:	F30 according DIN 4102-2
Fire reaction	:	Class B2 according DIN 4102-1

Electrical resistance

<10⁷ -Ω

Jansen Products NV

Fabriekstraat 4
3670 Meeuwen
BELGIUM

Tel : +32 11 79 33 00
Fax: +32 11 79 33 01
info@jansenproducts.be
www.groupjansen.com

complete certificates on request